

P/N: FAUI391757

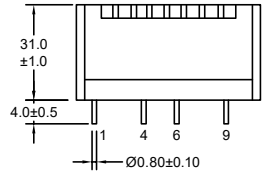

Outline Dimensions(Unit:mm)



Side View

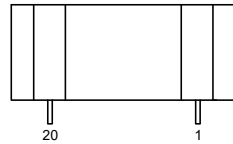

Front View

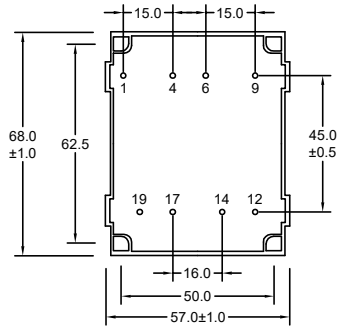

Bottom View

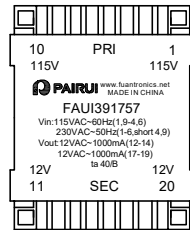

Top View

Note:

- 1.Remove Pins 2,3,5,7,8,10,11,13,15,16,18,20.

Wave Soldering

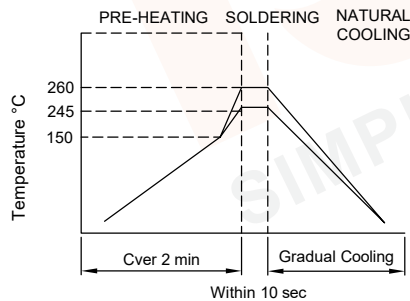

- Note:
- 1.Never Contact the ceramic with the iron tip;
  - 2.1.0mm tip diameter(max).

Electronical Schematic

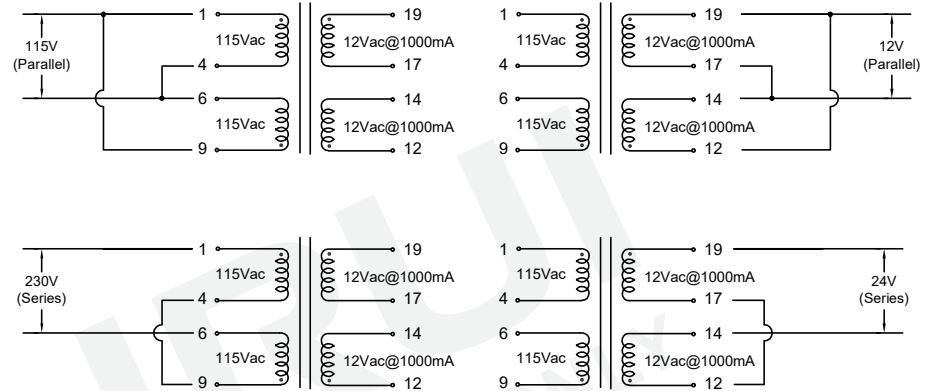

Electrical Characteristics

- Input 115Vac 60Hz to (1,9-4,6)  
or 230Vac 50Hz to (1-6,short 4,9) :
- Excitation current(Ix):60mA Max.  
No-load loss:1.5W Max.  
Output: Vo(12-14)=14.4Vac Typ(No-load).  
Vo(17-19)=14.4Vac Typ(No-load).  
VL(12-14)=12.0Vac±5%(@1000mA).  
VL(17-19)=12.0Vac±5%(@1000mA).
- Hi-Pot: Pri-Sec:4000VAC/5mA/60Second.

General Properties

- Operating Temperature:-40°C to +40°C.  
Storage Temperature:-25°C to +85°C.  
Insulation Class: B.  
Weight: 0.445kg.

|     |             |      |      |   |  |   |   |   |
|-----|-------------|------|------|---|--|---|---|---|
| REV | DESCRIPTION | APPD | DATE | Tianchang Fuan Electronic Co Ltd<br>www.fuantronics.net<br>TEL: +86-550-7814888<br>FAX: +86-550-7831133 | <br>Tolerances unless otherwise specified:<br>(.X)±0.50 (XX)±0.25<br>Unit of measurement: mm | Make: Qiumei.Liu<br>Checked: Beson. zhan<br>Approved: Anson. zhan | <b>DRAWING TITLE</b><br>24.0W Encapsulated Transformer<br>For UI39*17,2*115VAC Input 50/60Hz<br>Material Number: A223917XS020 | Customer Name:<br>Document/Rev:<br>Specification Sheet: 1 of 2<br>Date of Recognition: Jan./02/2020 |
|-----|-------------|------|------|---|--|---|---|---|

P/N: FAUI391757

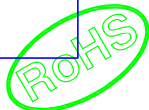

List of UL Certificate:

| No. | Part Name   | Mat'l Description       | Supplier                            | UL Number |
|-----|-------------|-------------------------|-------------------------------------|-----------|
| 1   | Bobbin      | UI39*17/PBT(Black)      | Chang Chun Plastics Co Ltd          | E59481    |
| 2   | Case        | CASE-UI39*17/PBT(Black) | Zhejiang Juner New Materials Co Ltd | E204321   |
| 3   | Copper wire | 2UEW-F/155C             | Elektrisola Hangzhou Co Ltd         | E258243   |
| 4   | Core        | Lamination              | Ta Yea Steel Industry Co Ltd        | N/A       |
| 5   | Epoxy       | PU552(Black)            | Wevo-Chemle Gmbh                    | E108835   |
| 6   |             |                         |                                     |           |

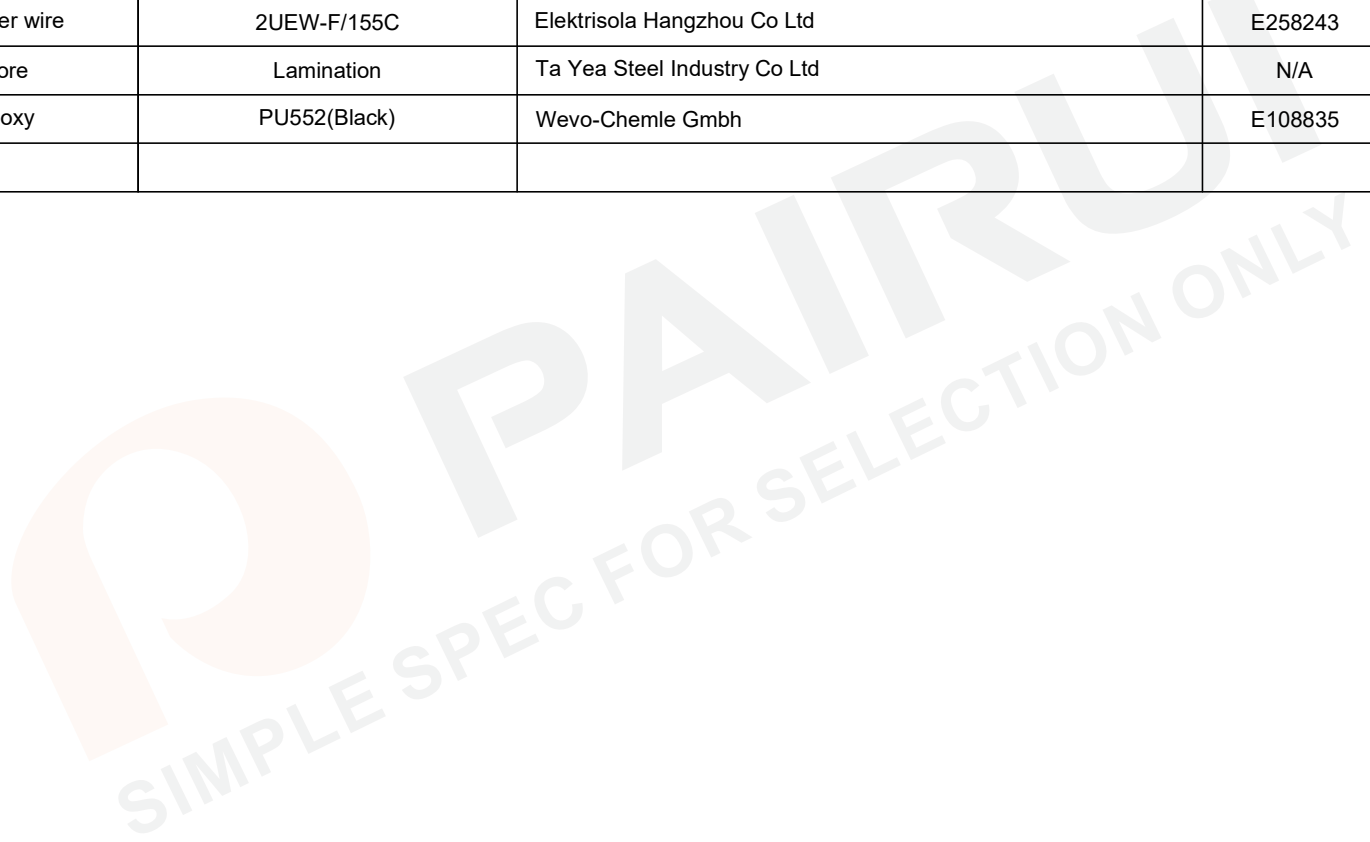

|     |             |      |      |   |  |   |  |  |
|-----|-------------|------|------|---|--|---|--|--|
|     |             |      |      | Tianchang Fuan Electronic Co Ltd<br>www.fuantronics.net<br>TEL: +86-550-7814888<br>FAX: +86-550-7831133 | Tolerances unless otherwise specified:<br>(.X)±0.50 (XX)±0.25<br>Unit of measurement: mm | Make: Qiumei.Liu                              | <b>DRAWING TITLE</b><br>24.0W Encapsulated Transformer<br>For UI39*17,2*115VAC Input 50/60Hz | Customer Name:                               |
| REV | DESCRIPTION | APPD | DATE |   |  | Checked: Beson. zhan<br>Approved: Anson. zhan |  | Document/Rev:<br>Specification Sheet: 2 of 2 |